

SOLATUBE AUSTRALIA MANUFACTURING SPECIFICATION

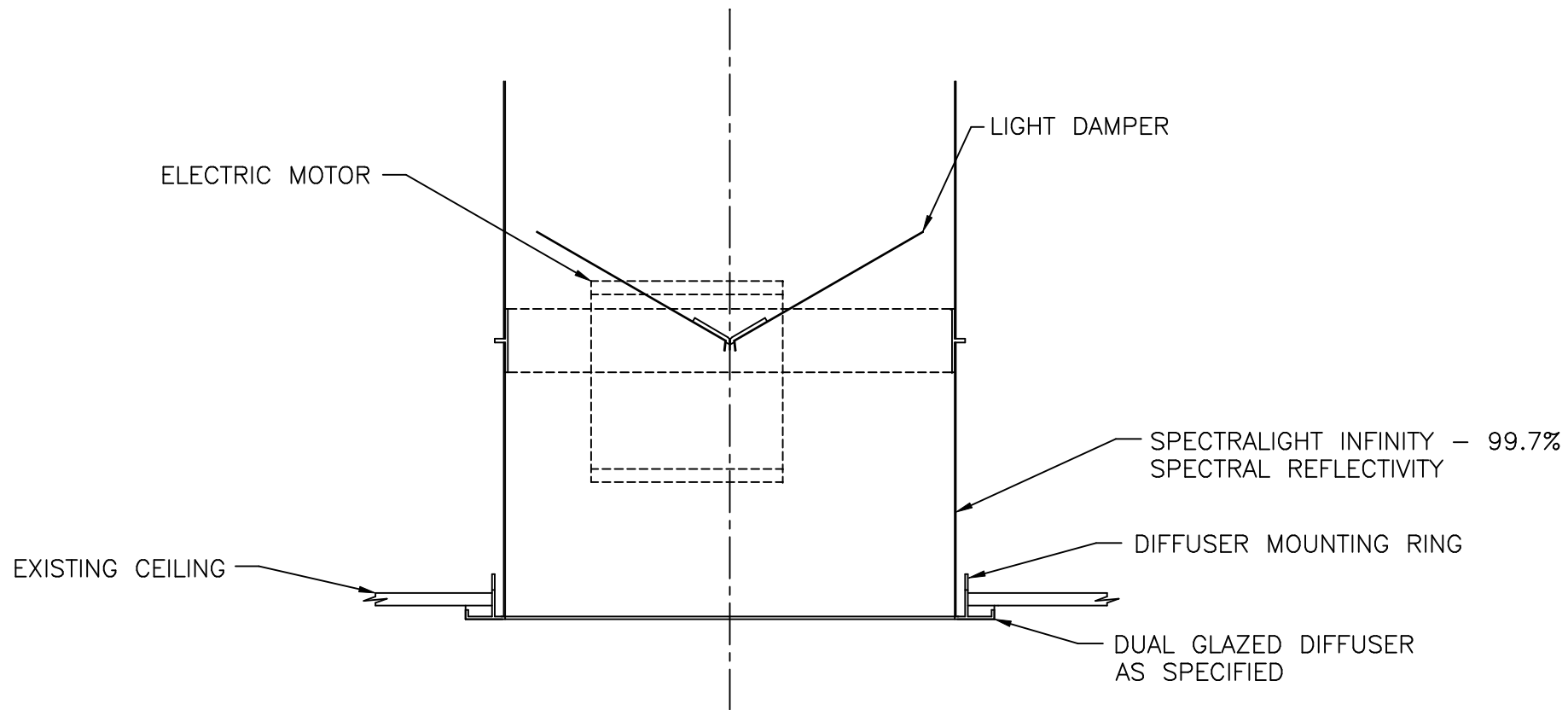

SECTION THROUGH & DIFFUSER
SCALE 1:5

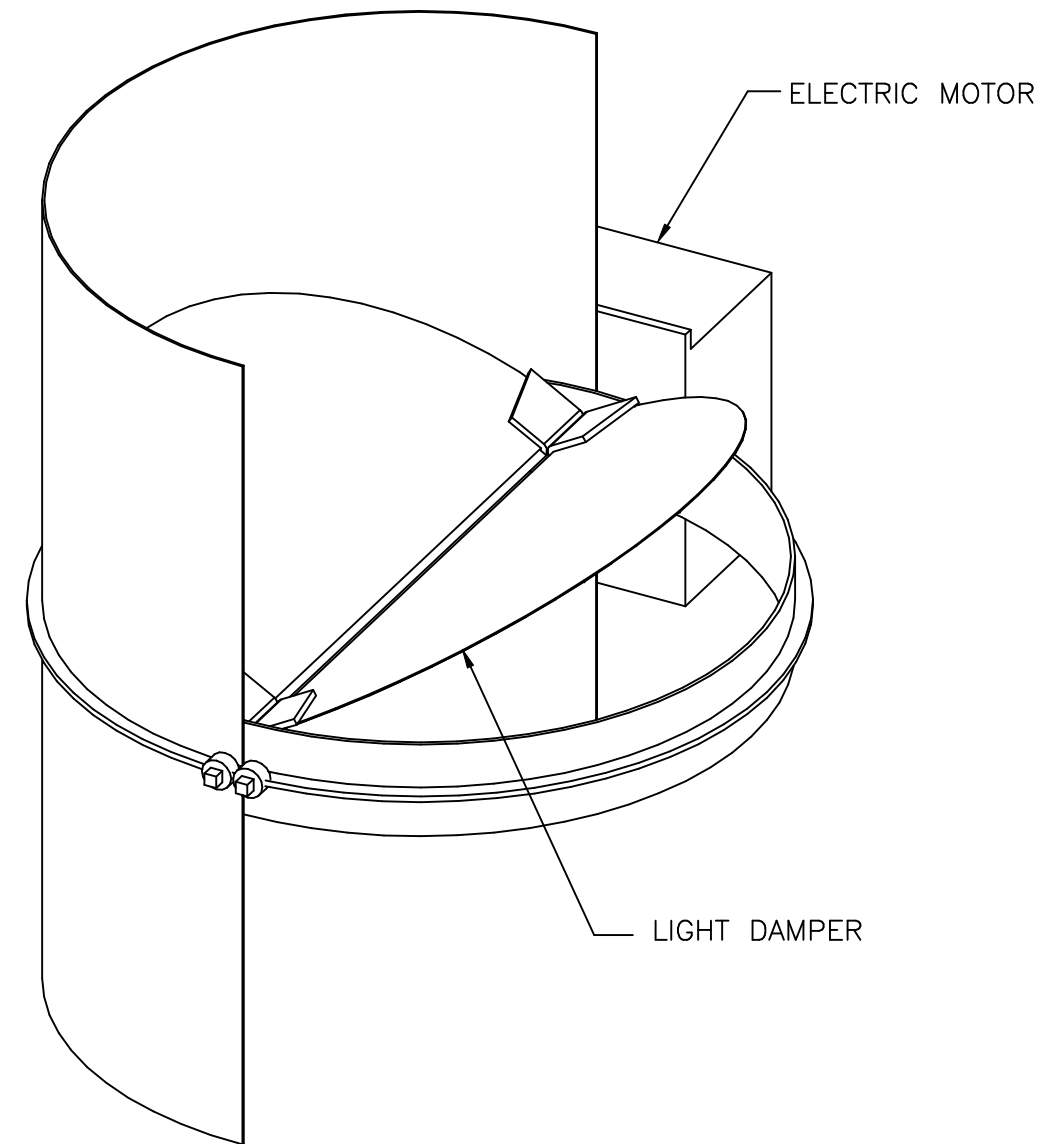

3D CUTAWAY VIEW - DETAIL A
SCALE N.T.S.

ACCESSORY CODE: A-570002

DIMMER SWITCH CODE: A-570001

DRAWN	PCR	REVISION	A
DATE	02/03/10	SCALE	1:5, NTS
APPROVED	PN	DWG NO.	290DS-LD
DATE	02/03/10		